

# Mechanical System and Control System of a Dexterous Robot Hand

Dirk Osswald, Heinz Wörn

University of Karlsruhe  
Department of Computer Science  
Institute for Process Control and Robotics (IPR)  
Engler-Bunte-Ring 8 - Building 40.28  
D-76131 Karlsruhe  
email: [osswald@ira.uka.de](mailto:osswald@ira.uka.de) , [woern@ira.uka.de](mailto:woern@ira.uka.de)

**Abstract:** In recent years numerous robot systems with multifingered grippers or hands have been developed all around the world. Many different approaches have been taken, anthropomorphic and non-anthropomorphic ones. Not only the mechanical structure of such systems was investigated, but also the necessary control system. With the human hand as an exemplar, such robot systems use their hands to grasp diverse objects without the need to change the gripper. The special kinematic abilities of such a robot hand, like small masses and inertia, make even complex manipulations and very fine manipulations of a grasped object within the own workspace of the hand possible. Such complex manipulations are for example regrasping operations needed for the rotation of a grasped object around arbitrary angles and axis without depositing the object and picking it up again. In this paper an overview on the design of such robot hands in general is given, as well as a presentation of an example of such a robot hand, the Karlsruhe Dexterous Hand II. The paper then ends with the presentation of some new ideas which will be used to build an entire new robot hand for a humanoid robot using fluidic actuators.

Keywords: Multifingered gripper, robot hand, fine manipulation, mechanical system, control system

## 1 Introduction

The special research area 'Humanoid Robots' founded in Karlsruhe, Germany in July 2001 is aimed at the development of a robot system which cooperates and interacts physically with human beings in 'normal' environments like kitchen or living rooms. Such a robot system which is designed to support humans in non-specialized, non-industrial surroundings like these must, among many other things, be able to grasp objects of different size, shape and weight. And it must also be able to fine-manipulate a grasped object. Such great flexibility can only be reached with an adaptable robot gripper system, a so called multifingered gripper or robot hand.

The humanoid robot, which will be built in the above mentioned research project, will be equipped

with such a robot hand system. This new hand will be built by the cooperation of two institutes, the IPR (Institute for Process Control and Robotics) at the University of Karlsruhe and the IAI (Institute for Applied Computer Science) at the Karlsruhe Research Center. Both organizations already have experience in building such kind of systems, but from slightly different points of view.

The 'Karlsruhe Dexterous Hand II' (see figure 1) built at the IPR, which is described here in detail, is a four fingered autonomous gripper. The hands built at the IAI (see figure 17) are built as prosthesis for handicapped people.

The approach taken so far will be presented and discussed in the following sections, as it founds the basis for the novel hand of the humanoid robot.

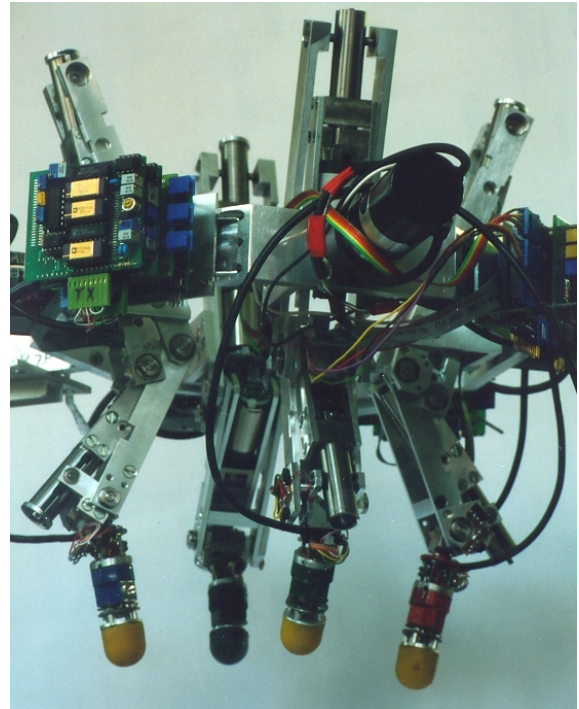

Figure 1: Karlsruhe Dextrous Hand II from IPR

## 2 General structure of a robot hand

A robot hand can be split up in two major subsystems:

- The mechanical system
- The control system

The mechanical system, further described in section 3, can be subdivided into:

- The mechanical design
- The actuator system
- The sensor system

And the control system described in section 4 consists at least of :

- The control hardware
- The control software

For each of these parts we will describe the considerations for a robot hand in general and then present the exemplary implementation in the Karlsruhe Dexterous Hand II.

## 3 Mechanical system

The mechanical system describes how the hand looks like and what kind of components it is made of. It defines the mechanical design, e.g. the number of fingers and the kind of materials used. Additionally actuators, e.g. electric motors, and sensors, e.g. position encoders, are settled.

### 3.1 Mechanical design

The mechanical design determines the fundamental 'dexterousness' of the hand, i.e. what kind of objects can be grasped and what kind of manipulations can be performed with a grasped object. Three basic aspects have to be settled when designing a robot hand:

- The number of fingers
- The number of joints per finger
- The size and placement of the fingers

To be able to grasp and manipulate an object safely within the workspace of the hand at least 3 fingers are required. To achieve the full 6 degrees of freedom (3 translatory and 3 rotatory DOF) for the manipulation of a grasped object at least 3 independent joints are needed for each finger. This approach was taken for the first Karlsruhe Dexterous Hand [1,2]. However, to be able to regrasp an object without having to release it and then pick it up again, at least 4 fingers are necessary.

To determine the size and the placement of the fingers two different approaches can be taken:

- Anthropomorphic
- Non-anthropomorphic

It then depends on the objects to manipulate and on the type of manipulations desired which one is chosen. An anthropomorphic placement allows to easily transfer e.g. grasp strategies from a human

hand to the robot hand. But the different sizes of each finger and their asymmetric placement makes the construction more expensive and the control system more complicated, because each finger has to be treated separately.

When a non-anthropomorphic approach is taken most often identical fingers are arranged symmetrically. This reduces the costs for the construction and simplifies the control system because there is only one single 'finger module' to be constructed and controlled.

### 3.2 Actuator system

The actuation of the finger joints also has a great influence in the dexterousness of the hand, because it determines the potential forces, precision and speed of the joint movements. Two different aspects of the mechanical movement have to be considered:

- Movement generation
- Movement forwarding

Several different approaches for these aspects are described in the literature. E.g. the movement can be generated by hydraulic or pneumatic cylinders [3] or, as in most cases, by electric motors. As the movement generators (motors) are in most cases too big to be integrated in the corresponding finger joint directly, the movement must be forwarded from the generator (most times located in the last link of the robot arm) to the finger joint. Again different methods can be used, like tendons [4,5,6], drive belts [1,2] or flexible shafts. The use of such more or less indirect actuation of the finger joint reduces the robustness and the precision of the system and it complicates the control system because different joints of one finger are often mechanically coupled and must be decoupled in software by the control system. Due to these drawbacks an integration of miniaturized movement generators directly into the finger joints is desirable.

### 3.3 Sensor system

The sensor system of a robot hand provides the feedback information from the hardware back to the control software. This is necessary to perform a closed loop control of the fingers or a grasped object. Three types of sensors are used in robot hands [7,8]:

- Gripper state sensors determine the position of the finger joints, and hence the finger tip, and the forces which act upon the finger. Knowing the exact position of the fingertip makes precise position control possible, which is necessary for dexterous fine manipulations. With the knowledge of the forces applied to a grasped object by the fingers it is possible to grasp a fragile object without breaking it.

- Grasp state sensors provide information about the contact situation between the finger and the object. This tactile information can be used to determine the point in time of the first contact with the object while grasping, and to avoid undesired grasps, like grasping at an edge or a tip of the object. But it can also be used to detect slippage of an already grasped object, which might lead to a loss of the object.
- Object state or pose sensors are used to determine the shape, position and orientation of an object in the workspace of the gripper. This is necessary if these data is not known exactly, prior to grasping the object. If the object state sensors still works on a grasped object it can be used to control the pose (position and orientation) of a grasped object too, e.g. to detect slippage.

Depending on the actuator system the geometrical information about the finger joint position can be measured at the movement generator or directly at the joint. For example if there is a stiff coupling between an electric motor and the finger joint then the joint position can be measured by an angle encoder at the axis of the motor (before or after the gear). This is not possible if the coupling is less stiff and a high position precision is desired.

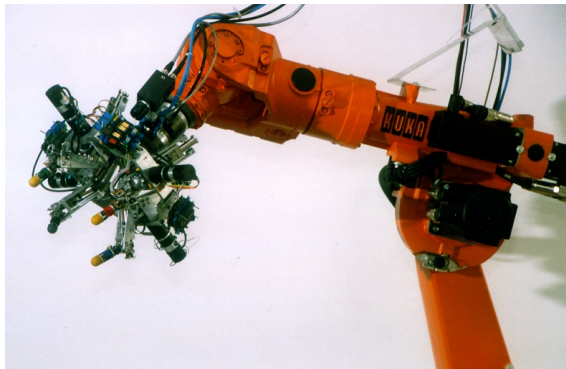

Figure 2: KDH II mounted on an industrial robot

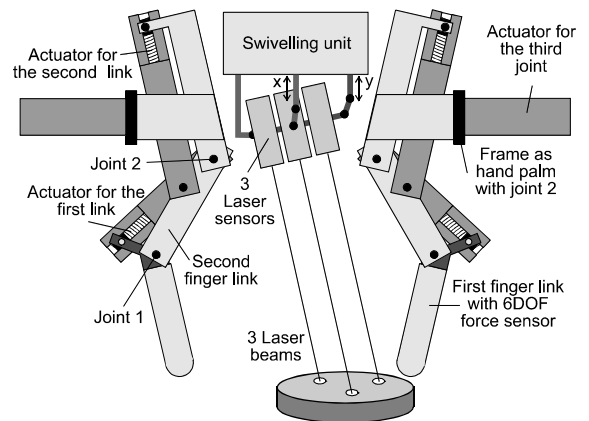

Figure 4: Side view of the KDH II

### 3.4 The mechanical system of the Karlsruhe Dexterous Hand II

In order to permit more complex manipulations like regrasping the current Karlsruhe Dexterous Hand II (KDH II) was built with 4 fingers and 3 independent joints per finger. It is designated for applications in industrial environments (see figure 2) and for manipulation of objects like boxes, cylinders, screws or nuts. Therefore a symmetric, non-anthropomorphic configuration of four identical fingers, each rotated by 90° was chosen (see figure 3).

Due to the experiences gained with the first Karlsruhe Dexterous Hand, like e.g. mechanical problems caused by the drive belts or controlling problems caused by large friction factors, some different design decisions were chosen for the KDH II. The dc-motors for joint 2 and 3 of each finger are integrated into the previous finger limb (see figure 4). This permits the use of very stiff ball-spindle-gears for the forwarding of the movement to the finger joint. Angle encoders directly on the motor axis (before the gear) are used as very precise position state sensors.

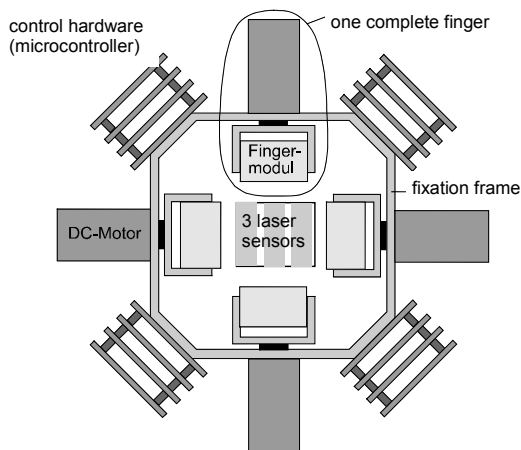

Figure 3: Top view of the KDH II

For sensing the forces applied to an object by a finger a prototype of a 6 dimensional force torque sensor has been developed (see figure 5). It can be used as the last finger limb and is equipped with a spherical finger tip. It is able to grasp light objects as well as relatively heavy objects up to 3 to 5 kg. The sensor is able to measure forces in x- y- and z-direction and torques around these axes. Additionally 3 colinear laser triangulation sensors are mounted in the palm of the KDH II (see figure 4) [11]. Because there are three such sensors not only the distances of 3 single points can be measured, but also the distance and orientation of the surface of a grasped object, if the shape of the object is known. This object pose sensor works with a frequency of 1 kHz which allows the detection and avoidance of a slipping object.

#### 4 Control system

The control system of a robot hand determines which of the potential dexterous skills provided by the mechanical system can actually be exploited. As mentioned before the control system can be subdivided in the control computer or hardware and the control algorithms or software. The control system must meet several conflicting requirements:

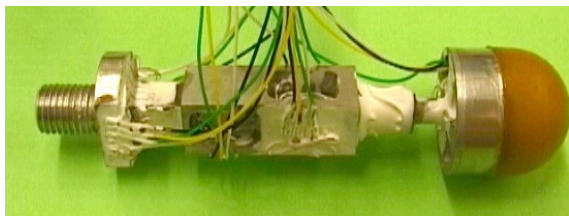
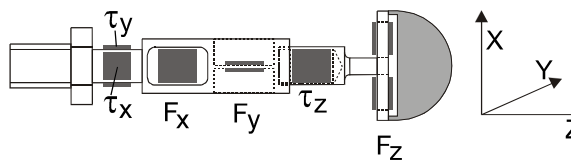

Figure 5: 6 DOF force torque sensor with strain gage sensors used as the last finger limb of the KDH II

- Many input/output resources like actor or sensor signals must be attached. For example for a minimum hand with 9 degrees of freedom, at least 9 analog outputs to the motors and 9 inputs from angle encoders must be estimated. With force and tactile sensors for every finger and additional object state sensors the number of inputs quickly increases to several dozens.
- Quick reactions in real-time to external events are required. If for example a slipping of the grasped object is detected immediate counter measures must be taken.
- High computing power for several different tasks must be available. For example path planning, coordinate transformations, closed

loop control in software are executed in parallel for multiple fingers as well as for the object.

- Small physical size is needed to be able to integrate the control system into the manipulation system.
- Short electrical connections between the control system and the actuators and sensors should be used. This is especially relevant for the sensors because otherwise massive interference might disturb the sensor signal.

#### 4.1 Control hardware

To cope with the requirements the control hardware is usually distributed among several specialized processors. For example the input/output on the lowest level (motors and sensors) can be handled by a simple microcontroller, which is also of small size and thus can be integrated more easily into the manipulation system. But the higher levels of control need more computing power and the support of a flexible real time capable operating system. This can be achieved most easily with PC-like components.

Therefore the control hardware often consist of a non-uniform, distributed computing system with microcontrollers on the one end and more powerful processors on the other. The different computing units then have to be connected with a communication system, like for example a bus system.

#### 4.2 Control software

The control software of a robot hand is quite complex. Several fingers must be controlled in real-time and in parallel while new trajectories for the fingers and the object must be planned at the same time. Therefore it is necessary to reduce the complexity by dividing the problem into sub problems.

Another aspect concerns software development. As a robotic hand is usually a research project for most of it's lifetime, the programming environment, like user interface, programming tools and debugging facilities, should be powerful and flexible. This can only be achieved if a standard operating system is used.

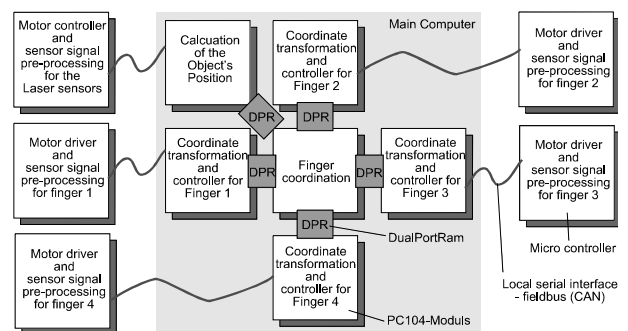

Figure 6: control hardware architecture of the KDH II



The usual hierarchical control system approach used in robotics has to be trimmed to fit the special needs of the controlling of a robot hand.

### 4.3 The control system of the Karlsruhe Dexterous Hand II

As suggested in section 4.1 a distributed approach to the control hardware was taken for the Karlsruhe Dexterous Hand II (KDH II) (see figure 6) [8]. One microcontroller is used to control the actuators and sensors of one finger respectively. An additional microcontroller is used for the object state sensor (laser triangulation sensors). These microcontrollers (the outer boxes to the left and right in figure 6) are mounted directly on the hand, thus short electrical connections to the actuators and sensors are guaranteed. The microcontrollers are connected to the main control computer by serial bus systems (CAN-bus).

The main control computer of the KDH II (the light grey box in figure 6, and figure 7) is implemented as a parallel computer consisting of 6 industrial PCs (PC104 standard). These PCs are arranged in a 2D-plane. Neighboring PC-modules (a PC has at most 8 neighbors) use a dual ported RAM (DPR) for fast communication (the dark grey boxes in figure 6).

One PC is used to control a finger respectively. One PC controls the object state sensors and calculates the object's position. The remaining PC is placed such that it neighbors all the previously mentioned PCs. It is used for the coordination of the whole control system

The structure of the control software reflects the control hardware architecture. It is shown in figure 8.

On the three top levels of the local hand control system an on-line planning is performed. Desired

object movement commands are received from the superior robot control system and used for a fine planning of the object path. According to the generated object path feasible grasps (possible grasp points for fingers on the object) are planned. Now that the grasps and the object movements are known the trajectories for each finger are planned by the finger path planning and forwarded to the real-time capable part of the system.

If an object is already grasped, then the finger movement paths are forwarded to the object pose controller. This controller controls the actual object pose, determined by the gripper and object state sensors, to reach the desired object pose. If a finger is not attached to an object, then its movement path is forwarded directly to the hand controller.

The hand controller coordinates the movements of all fingers by forwarding correspondent desired finger positions to all finger controllers. These in turn drive the finger actuators with the help of the finger sensors.

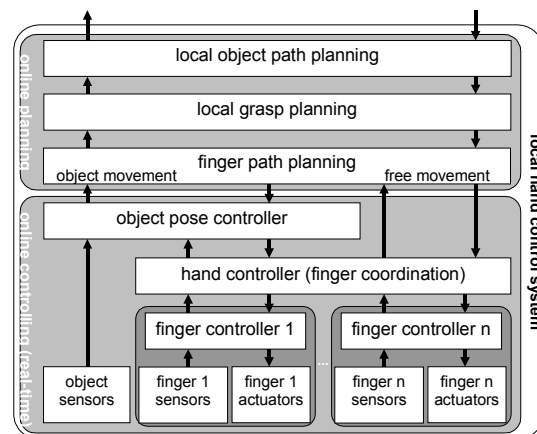

Figure 8: local hand control system of the Karlsruhe Dexterous Hand II

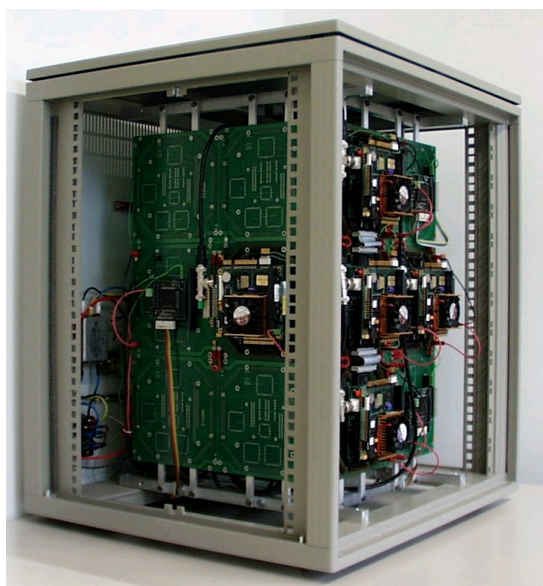

Figure 7: parallel main computer used to control the KDH II

## 5 Experimental results

To validate the capabilities of the Karlsruhe Dexterous Hand II two demanding manipulation problems were chosen. One problem is the on-line controlling of the pose (position and orientation) of a grasped object under external influences. Here the hard real-time conditions reveal the controlling capabilities of the approach chosen.

For the other problem a grasped object must be rotated around arbitrary angles, which can only be achieved with regrasping. This reveals the capability of the Karlsruhe Dexterous Hand II to perform very complex manipulation tasks.

### 5.1 Object pose control

The objective of the object pose controller is to correctly position and orientate a grasped object to fit a given trajectory. This task must be achieved on-line under real-time conditions and in spite of internal variations and external disturbances.

Internal variations are for example the rolling of the spherical fingertips on a grasped object during object movements in the workspace of the hand.

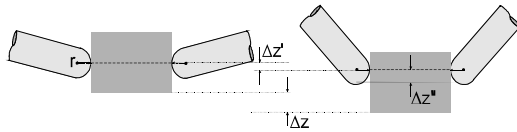

Figure 9: additional displacement due to rolling

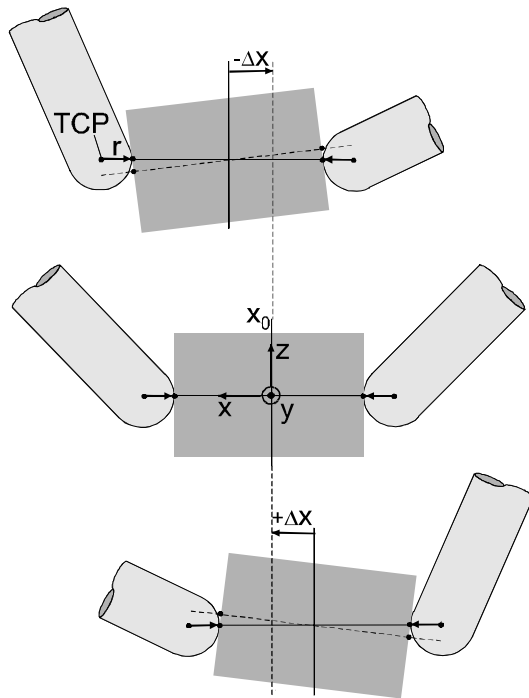

Figure 10: additional undesired tilt due to rolling of the spherical fingertips on the object

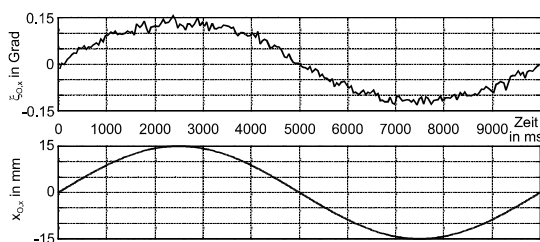

Figure 11: Object tilt **without** object state control

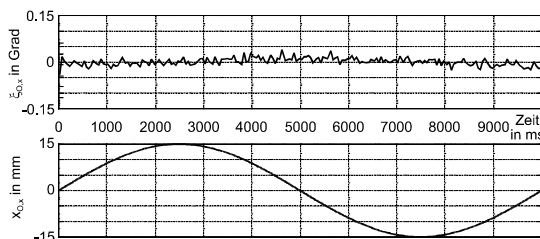

Figure 12: Reduced object tilt **with** object state control

This rolling is shown in figure 9 and figure 10. It can result in an undesired additional displacement or in an undesired tilt of the object. These object pose errors are hard to estimate in advance.

Therefore the input of an object pose sensor is needed to correct the errors. For the Karlsruhe Dexterous Hand II the three laser triangulation sensors were used for this purpose.

Figure 11 shows the undesired tilt of the object according to figure 9 quantitatively when no object pose control is used. The lower diagram shows the desired trajectory over time in x-direction, while the upper diagram shows the resulting undesired rotation (tilt) of the object.

In figure 11 the tilt of the object is significantly reduced due to the enabled object pose control. In the upper diagram the rotation of the object remains essentially constant, as desired.

An object pose controller is also necessary to compensate external disturbances. For example collisions of the robot (arm, hand or fingers) or the grasped object with the environment might result in the slipping of the grasped object. This might even lead to the loss of the grasped object and is therefore not acceptable. In order not to lose the object in such situations the slipping must be detected and a quick reaction must be performed to stabilize the object pose.

To verify the capability of the Karlsruhe Dexterous Hand II control system to cope with this kind of

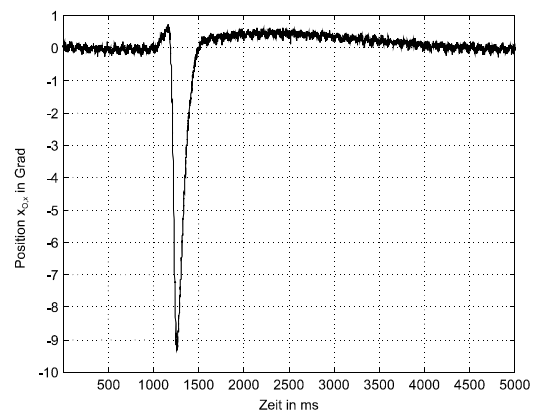

Figure 13: Slipping experiment: actual object position in x-direction (direction of slipping)

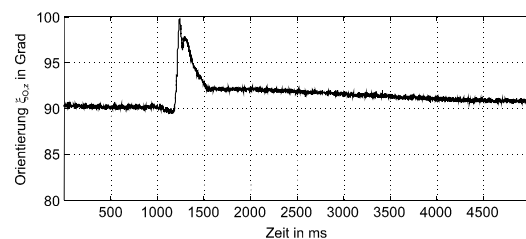

Figure 14: Slipping experiment: actual object orientation about z axis

disturbances the following experiment was made: While an object was grasped the finger-contact-forces were constantly reduced until the object began to slip. After the slipping was detected with the laser triangulation sensor the object pose controller took measures to recontrol the object to the desired pose.

Figure 13 and figure 14 show an example of such an experiment. Especially figure 13 shows that the object slipping starts quite abrupt and is quite fast. But the object pose controller reacts fast enough to detect and compensate the slipping so that the object position (here: especially in x-direction, the direction of the slipping) and the object orientation is restabilized to the original desired value quickly.

## 5.2 Regrasping

Although the Karlsruhe Dexterous Hand II is very flexible it can not perform every desired object manipulation at first go. This originates from the fact that the fingers are very small compared to 'normal' industrial robots and therefore only have a limited workspace. If an object is grasped with the fingers it can at first only be manipulated in a subspace of all the fingers workspaces. The condition for a feasible manipulation is that all the contact points must be permanently inside the workspace of the contacting finger. This limits the feasible manipulations considerably.

To overcome this limitation a so called regrasping operation must be performed. I.e. when a contact point reaches the limitation of the contacting finger, that finger must be detached from the object and reattached at a new contact point. This is only possible reliably by a hand with more than 3 fingers. By cyclically regrasping all fingers arbitrary object manipulations can be performed. An example of such a manipulation where regrasping is necessary is rotation of the grasped object about large angles. Figure 15 shows a sequence of photographs of the Karlsruhe Dexterous Hand II rotating a nut shaped object. The object is rotated about its vertical axis. In the sequence a) to c) all fingers are attached to the object and it is rotated by coordinated movements of all four fingers. The sequences d) to f) show a regrasping action for one single finger. In d) the fingers have reached their workspace limits and the coordinated movements of all fingers is stopped. The finger to the front left is detached from the object and moved separately to another contact point. In f) the finger is reattached to the object and another finger can be repositioned (not shown). After all fingers are repositioned the coordinated rotation operation continues.

Depending on the circumstances the Karlsruhe Dexterous Hand II is also able to regrasp several fingers simultaneously. This speeds up the regrasping process but is only possible if the grasped object is in contact with the environment, like for example a nut on a screw or a peg in a hole.

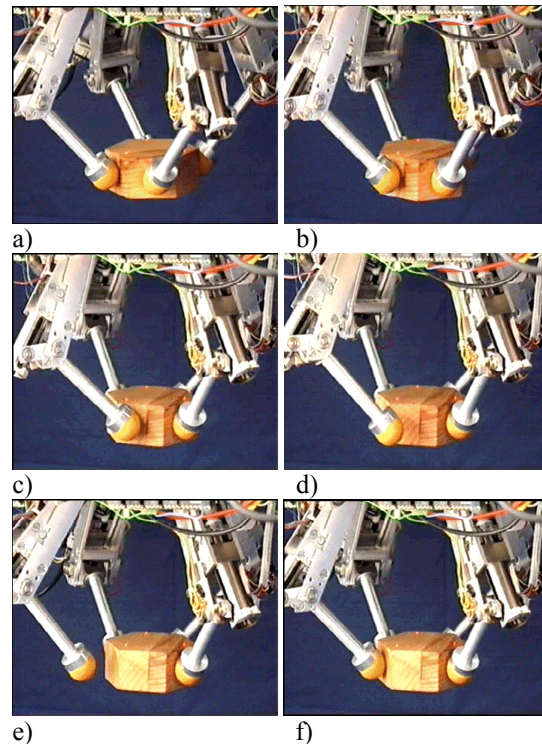

Figure 15: rotation of a nut shaped object with regrasping.

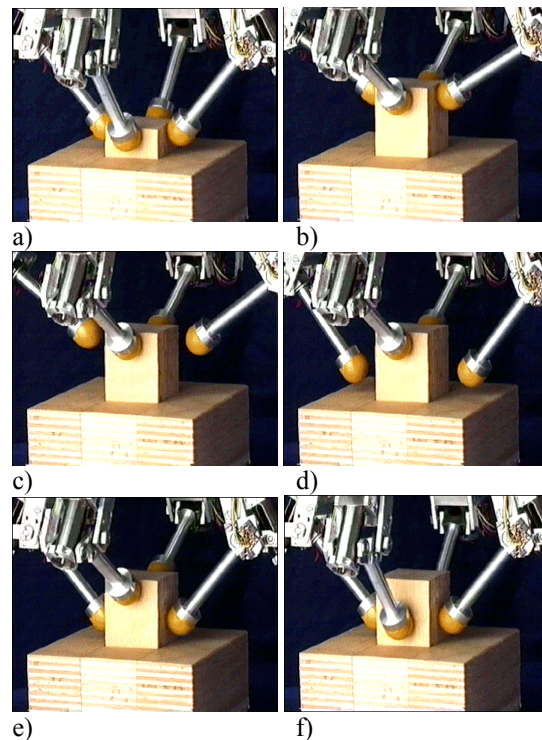

Figure 16: pulling a peg out of a hole with regrasping

Figure 16 shows a sequence of photographs of the Karlsruhe Dexterous Hand II. pulling a peg with a square base out of a hole. The peg is pulled out half way in sequence a) to b) then the left and the right finger are detached and repositioned, both fingers



at the same time, sequence c) to e). After that the finger in the front and back are also repositioned, sequence f). After that the whole peg can be pulled out of the hole for further manipulations (not shown)

## 6 Conclusion

To be able to perform dexterous fine manipulations with a robot hand a suitable mechanical system and control system is necessary. The introduced criterions for these systems must be considered as shown in this paper. This was done successfully for the Karlsruhe Dexterous Hand II. This robot hand is capable of grasping a wide variety of objects of different shape, size and weight. The pose of a grasped object can be controlled reliably, even under external disturbances. Additionally complex fine manipulations, like regrasping, are possible with this system.

The novel hand to be built in the context of the 'humanoid robots' special research area, will be anthropomorphic and mechanically based on a very different concept called fluidic actors (see figure 17) developed at the IAI in the Karlsruhe research center [12]. However the principal structure of the control software will be adapted and used for the novel hand.

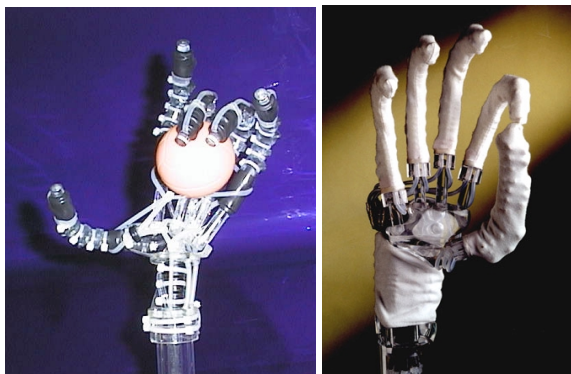

Figure 17: fluidic hands developed at the IAI

## 7 Acknowledgements

This paper is based on research done at the Institute for Process Control and Robotics Prof. Dr.-Ing. H. Wörn, as well as on the research done at the Institute for Applied Computer Science Prof. Dr.-Ing. G. Bretthauer.

## References

- [1] Th. Doersam and Th. Fischer, Aspects of Controlling a Multifingered gripper, International Conference on Conventional and Knowledge-based Intelligent Electronic Systems, 1997
- [2] Th. Doersam and P. Dürschmied, Compensation of friction in mechanical drives

- for a three fingered robot gripper, Proc. of the 1996 IEEE/RSJ Int. Conf. on Intelligent Robots and Systems, IROS, Osaka, Japan, Nov. 1996
- [3] R. Menzel, Konstruktion und Regelung einer Hand, Fortschritt-Berichte VDI-Reihe 8 Nr. 451, 1995
- [4] J.K. Salisbury, Articulated Hands: Force Control and Kinematics Issues, Phd thesis, Stanford University, 1982
- [5] G. Hirzinger, Mechatronik-Konzepte nicht nur für die Raumfahrt, Deutsche Forschungsanstalt für Luft- und Raumfahrt, Hannover Messe, 1996
- [6] W. Paetsch, Exemplarische Untersuchungen zu mehrfingrigen Robotergreifern: Aufbau-Regelung- Systemintegration, Fortschritt-Berichte VDI-Reihe 8 Nr. 363, Düsseldorf, 1993
- [7] B. Magnussen, Infrastruktur für Steuerungs- und Regelungssysteme von robotischen Miniatur- und Mikrogreifern, Fortschritt-Berichte VDI Reihe 8, Nr.567, Düsseldorf: VDI-Verlag, 1996
- [8] T. Fischer and H. Woern, Structure of a robot system: Karlsruhe Dexterous Hand II, Mediterranean Conference on Control and Systems, 1998
- [9] Th. Doersam and Th. Fischer, Using Fuzzy Controllers for the Karlsruhe Dexterous Hand, The Int. Symposium on Intelligent Robotic Systems, SIRS, Lisbon, Portugal, 1996
- [10] Th. Fischer and J. Seyfried, The new Karlsruhe Dexterous Hand II, Int. Sym. on Intelligent Robotic Systems, 1997
- [11] T. Fischer and H. Woern, Multifinger Grippers for Human-like Robots in Industry, World Multiconference on Systemics Cybernetics and Informatics, Orlando, Florida, 1999
- [12] S. Schulz, C. Pylatiuk, and G. Bretthauer. A new class of flexible fluidic actuators and their applications in medical engineering. In *at- Automatisierungstechnik* 47, pages 390-395, 1999